

生産中止図面

1999/03

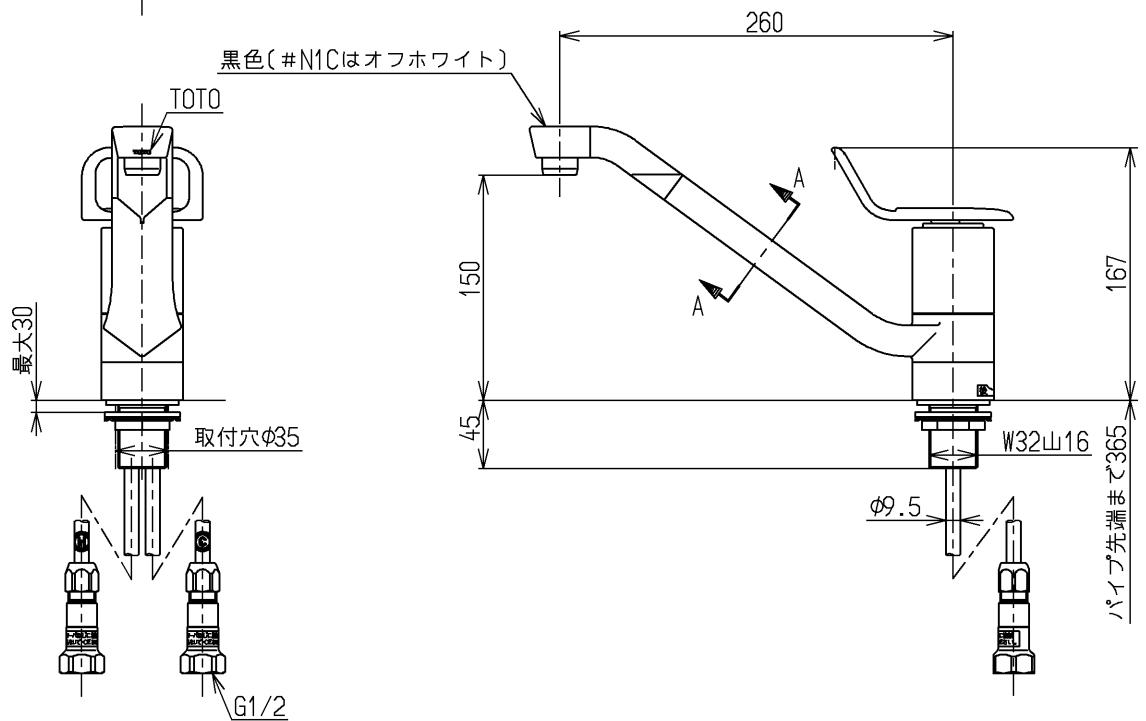
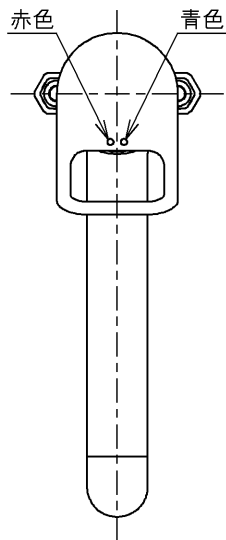

JIS品又は日本水道協会検査品

TOTO			単位 mm	名称 台付シングル13 (台所) (JIS)
製図 中野	検図 有利松	日付 梅本 99.2.9	尺度 1:5	図番
備考 逆止弁付				TK681X