

- <付属品>
レバーハンドル ×1
取付金具 ×1
止水栓 ×1

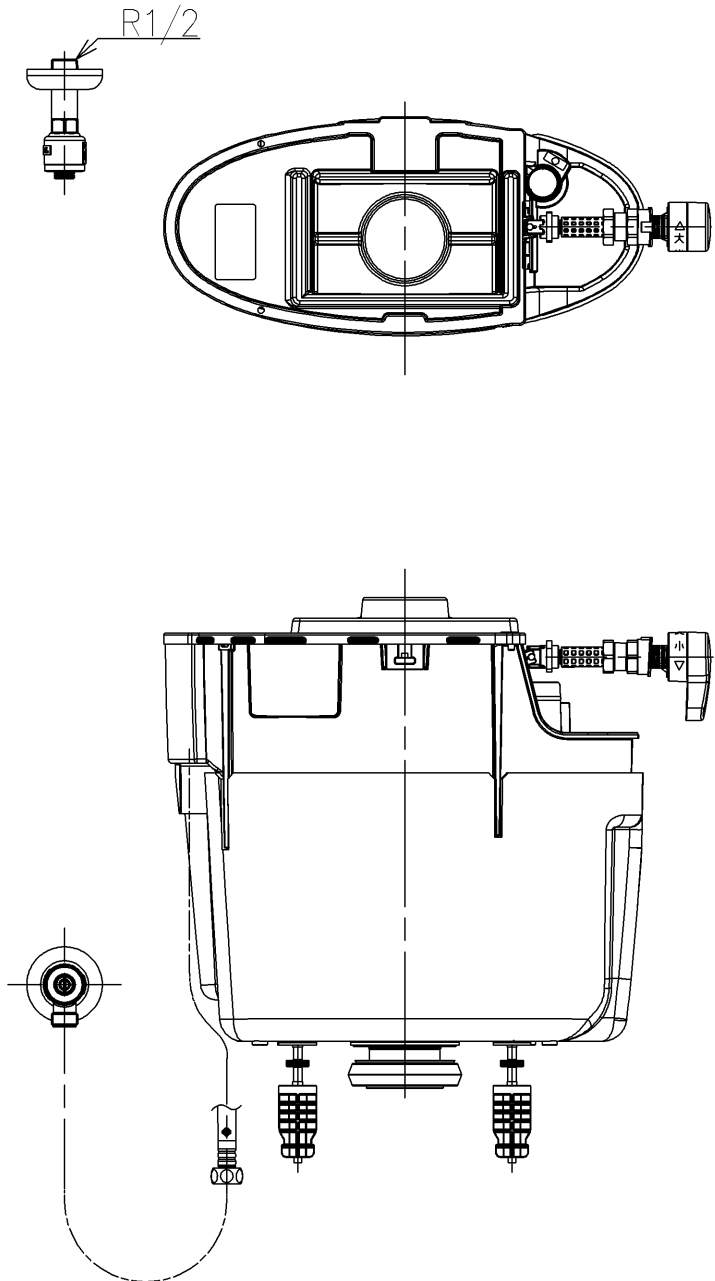

止水栓は床、壁共通使用可

TOTO		UNIT mm	SCALE 1:6	DATE 2023-Jun-16	DRAWN Shota.Sadakane
TITLE	内部樹脂タンク式 INNER RESIN TANK UNIT				CHECKED Koji.Sakoda
REMARKS	止水栓含む				APPROVED Hiroshi.Ono
					ITEM NUMBER HH11242RN

※日本販売品の衛生陶器の寸法許容差はJIS A5207に準ずる