

<梱包数>

カバー ×1
ALGCテープ ×1
プレート ×1
ねじ ×1
施工説明書 ×1

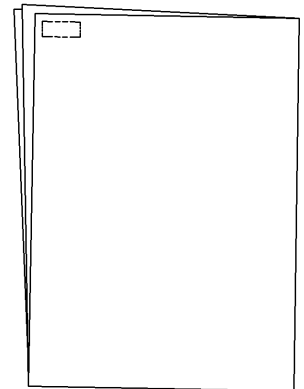
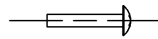
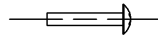
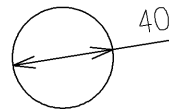
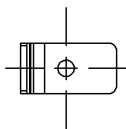
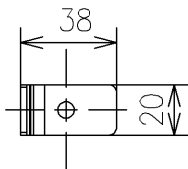
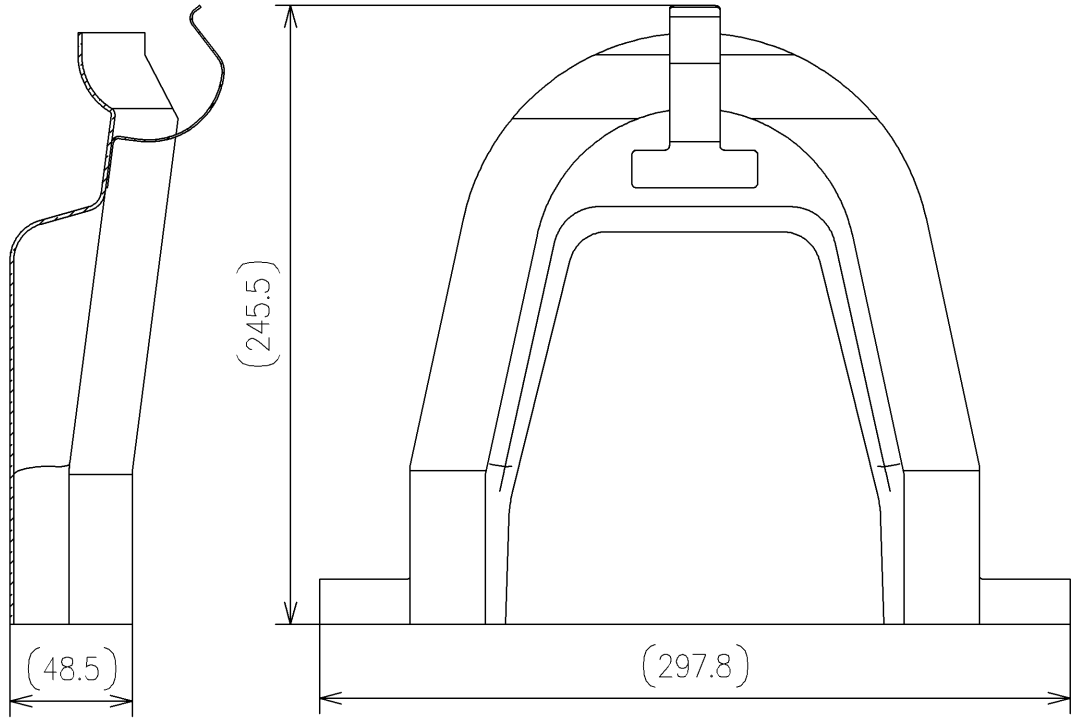

TOTO		UNIT mm	SCALE 1:2	DATE 2026-Mar-27	DRAWN daiki.okabe
TITLE	大便器背面カバー（防火区画対応）				CHECKED makoto.bekki
	REAR COVER (FOR FIRE COMPARTMENT)				APPROVED hideki.tanimoto
REMARKS	防火区画対応、床排水用				ITEM NUMBER HM410

※日本販売品の衛生陶器の寸法許容差はJIS A5207に準ずる