

付属品

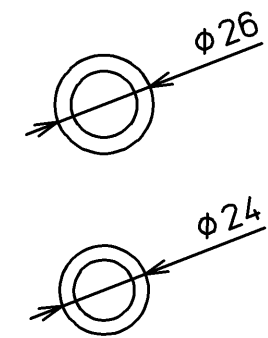

パッキン:2個

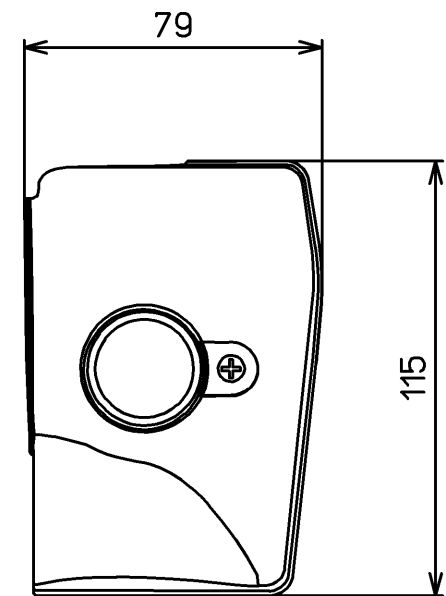

ケース組品:1個

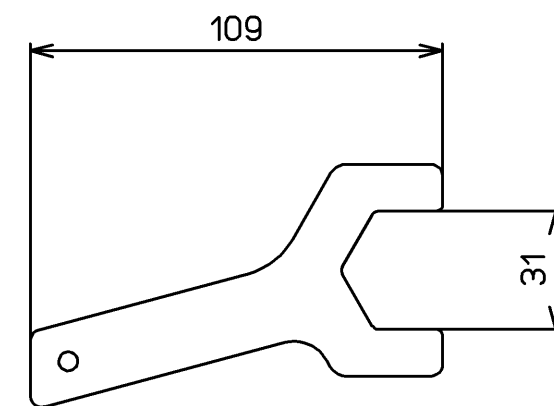

工具:1個

TOTO			単位 mm	名称 分岐金具組品
製図 基本	検図 入 末 江 次	日付 16-01-04	尺度 1 : 2	品番 TCA279
備考				図番 TCA279=A0100
A3		ページNo.	1-1	(改)