

<梱包数>

止め金具t=2.5 X2  
 ナットM8 X2  
 TボルトW5/16山18×37 X2  
 六角ボルトM8×35 X2  
 十字穴付きトラスタッピンねじ4種5×50 X4  
 ワッシャー8.5×28×2 X2

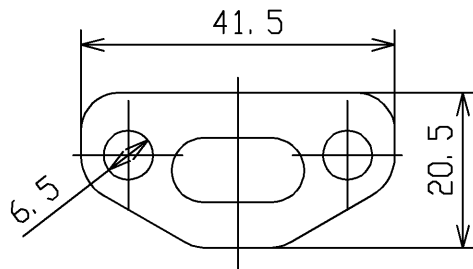

**TOTO**

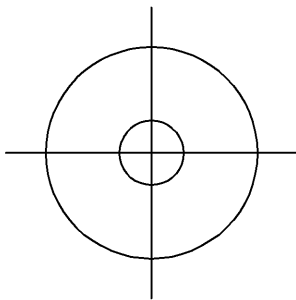
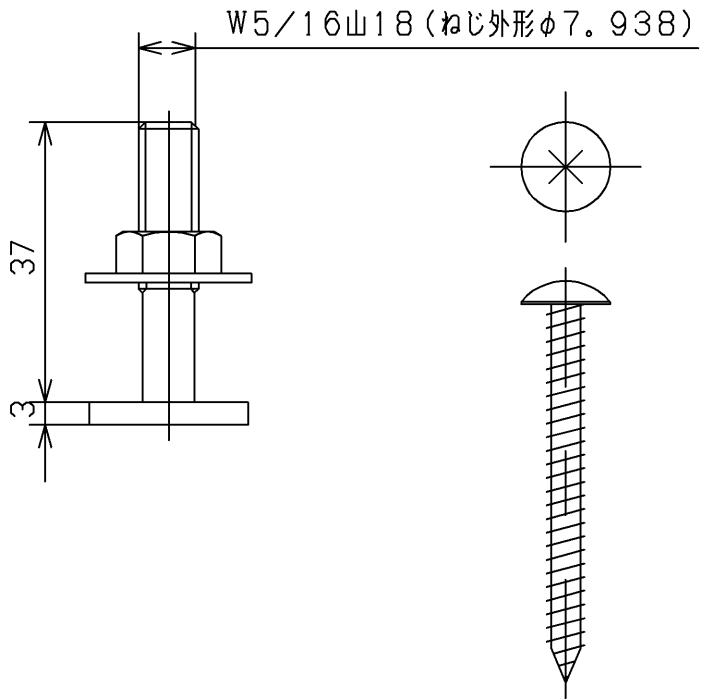
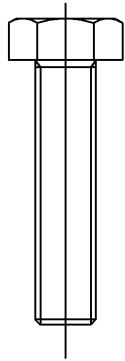
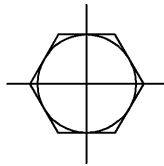
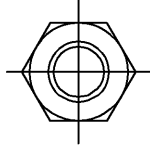
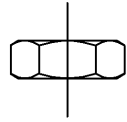
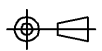

単位 mm

名称

製図

米

検図

稲垣

新川

日付

18/04/18

尺度

1: 1

固定具類

品番

HH04126

図番

HH04126=D2

備考

A4

ページNo.

1 / 1

(改)